

Isokern IBV 46" Fireplace

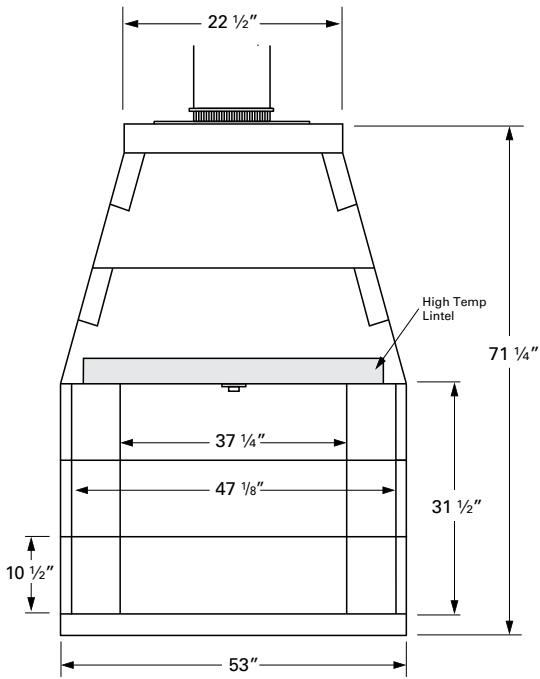

6899 Phillips Industrial Blvd. • Jacksonville, FL 32256

Project Name: _____ Location: _____



Front View

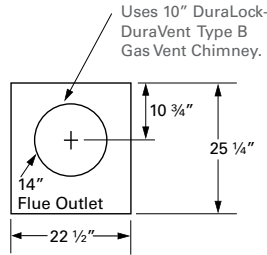

Top View

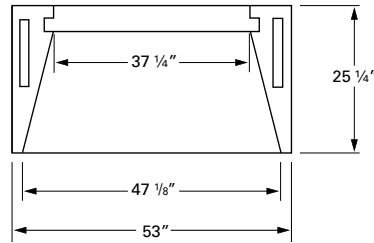

Plan View

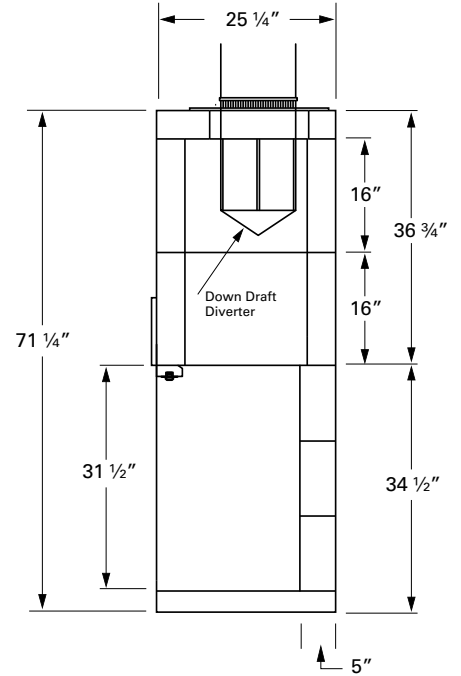

Side View

MINIMUM FRAMING DIMENSIONS

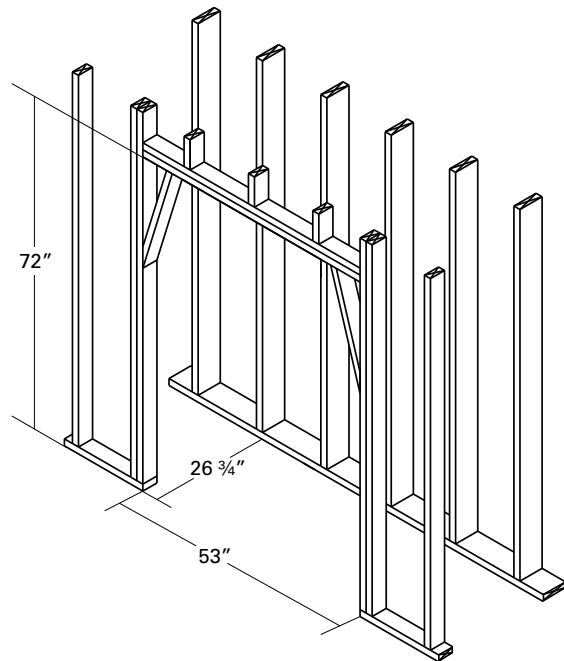

Framing dimensions maintain 1 1/2" clearance to combustibles. This is the standard framing height for the model shown. Refer to product manual for other framing height openings and further installation instructions.

FIREPLACE OPTIONS

- Hearth Height: _____
- Opening Height: _____
- Brick Type: _____
- Brick Color: _____
- Brick Pattern: _____
- Chimney Type: _____
- Offset: _____
- Decorative Termination: _____

Notes: _____

The total weight for the IBV 46" fireplace is approximately 1700 lbs. This dry weight includes fireplace pumice components only, additional weight from mortar, damper, firebrick and chimney not included.